

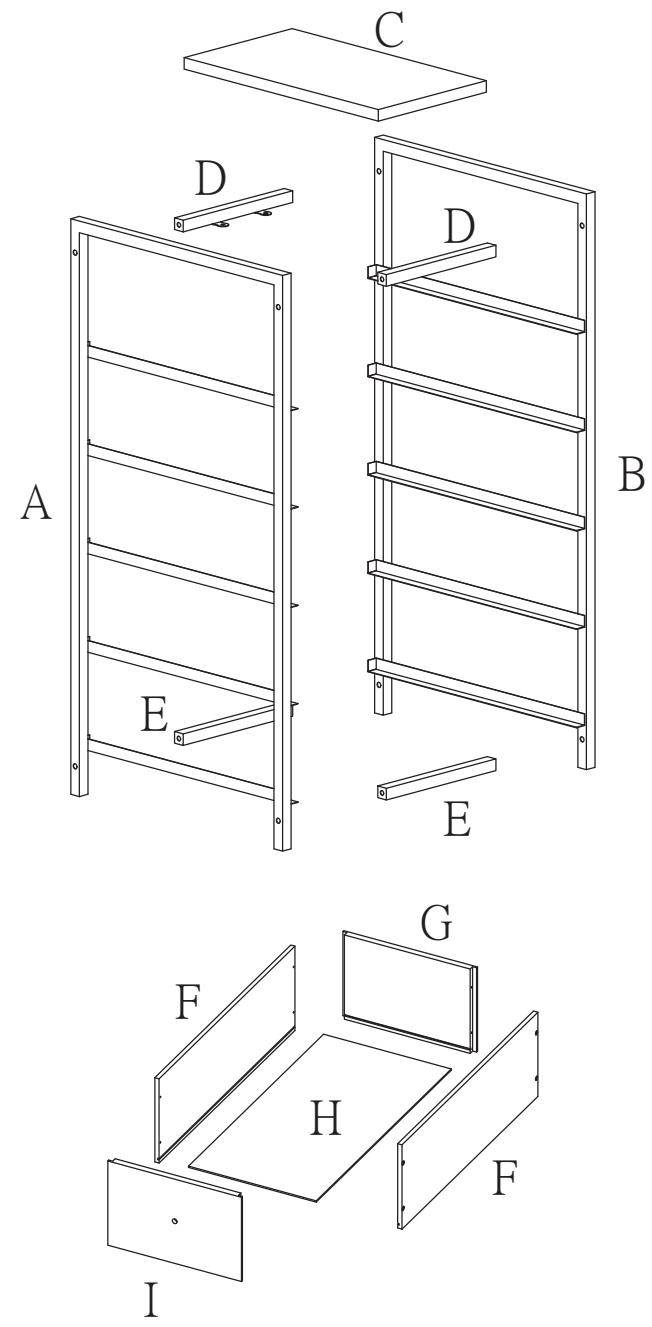

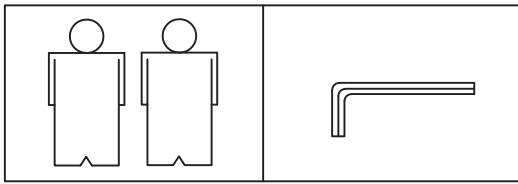

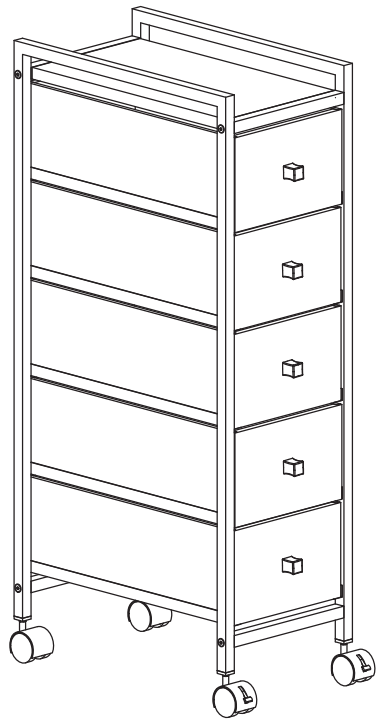





living
b.p.c
 bonprix collection

909146



| |
|--------|
| A x 1 |
| B x 1 |
| C x 1 |
| D x 2 |
| E x 2 |
| F x 10 |
| G x 5 |
| H x 5 |
| I x 5 |

| | | | | | | | | | | | | | | | | | | | | | | | | | |
|---|---|---|---|--|--|---|--|---|---|----|----|----|----|----|----|----|----|----|----|----|----|----|----|----|----|
|  |  |  |  | 4 * 9  | 4.76 * 12  | 3.2 * 16  | 6.35 * 28  |  | | | | | | | | | | | | | | | | | |
| a x 4 | b x 2 | c x 2 | d x 5 | e x 4 | f x 5 | g x 40 | h x 8 | i x 1 | | | | | | | | | | | | | | | | | |
| 0 | 1 | 2 | 3 | 4 | 5 | 6 | 7 | 8 | 9 | 10 | 11 | 12 | 13 | 14 | 15 | 16 | 17 | 18 | 19 | 20 | 21 | 22 | 23 | 24 | 25 |



e x 4

(1)

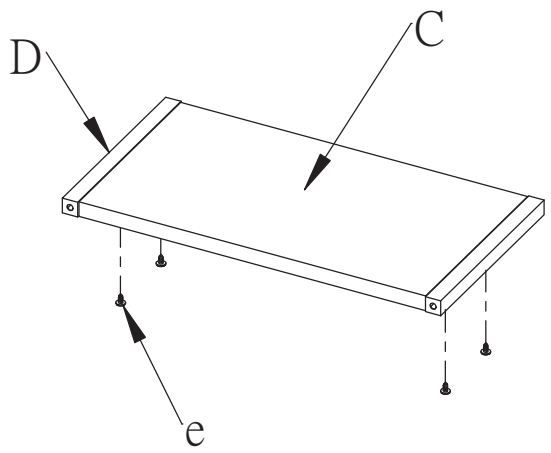

a x 4 b x 2 c x 2 h x 8

i x 1

(2)

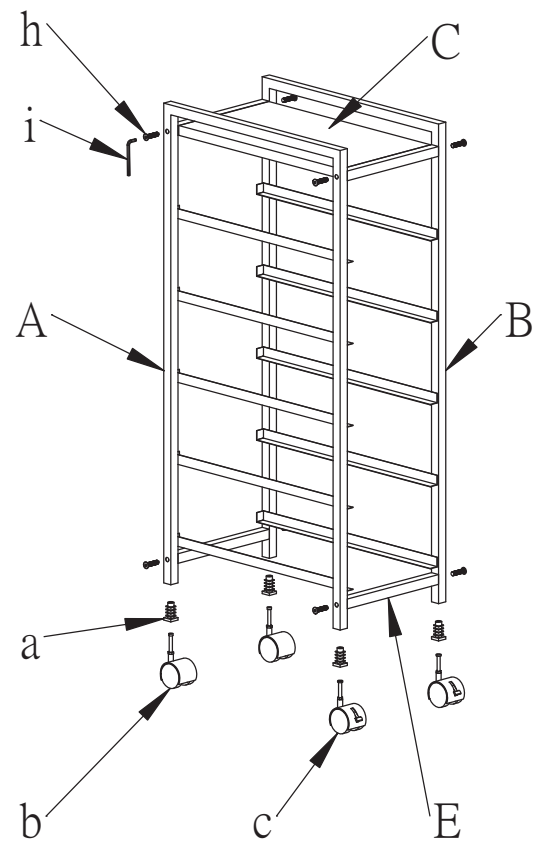

d x 5 f x 5 g x 40

(3)

